

The Core Family

The Core family line offers a rich diversity of technical and aesthetic options. Our 3" round wall wash offers 14+ finishes & custom wood choices. A wide range of source/optic selections, 3 ranges of Ambient Dim™ (Warm Dim), and a plethora of driver/control options including TruPhase™ (phase dimming down to 0.1%). Our Core product family is created on platform allowing for a high degree of modification

PROJECT:

TYPE:

SPECIFIER:

DATE:

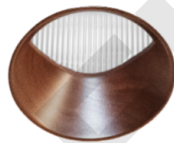
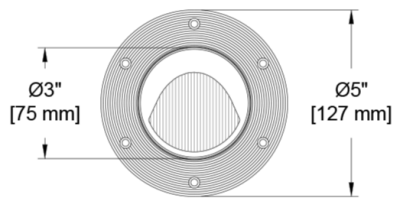
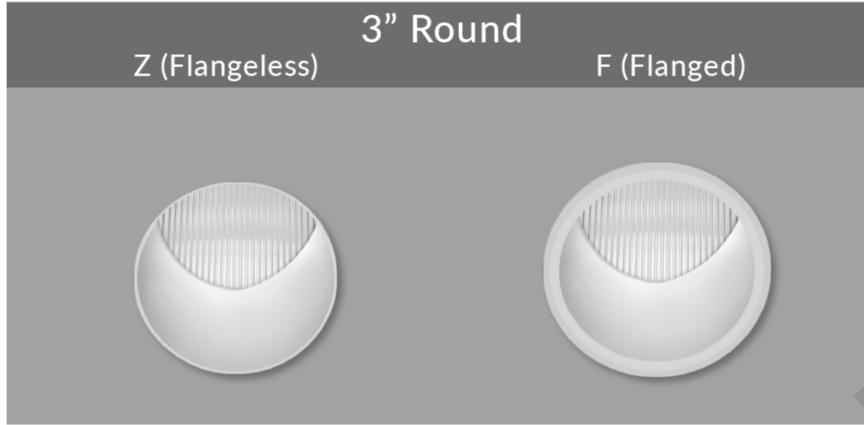

Available in Wood Trims

Key Points (CR3WW-RF)

Trim

- Flange or Flangeless
- Supertex spread lens, hinged for source and driver service
- Flangeless includes plaster flange
- 14 color options + custom RAL or wood available
- One-piece die cast aluminum or machined wood trim

Source / Optics

- Lifetime: L87B3 >55,000 hours at 40°C ambient
- 2400K, 2700K, 3000K, 3500K, 4000K Ambient Dim, RGBW & Tunable White options
- 90 CRI, 60+ R9 Standard- 95 CRI 90+R9 Optional
- <2 MacAdam Steps (<2SDCM) for fixed white
- Up to 914 delivered lumens (Based on 3000K CCT @ 90+ CRI)
- Uniform light from floor to ceiling. Achieves a 3.7:1 ratio on a 10' ceiling at 2.0' setback with a 1:1 on center spacing

Housing

- Compliant to with Airtight Housing (C14 source only)
- Listed – Damp or wet with shower trim
- Approved for 8 (4-in / 4-out) #12 AWG conductors rated for 90°C through wiring
- IC Rated / Airtight Housing approved for use in direct contact with insulation – Chicago Plenum Available
- Heavy gauge steel for new construction or remodel

Driver

- TruPhase™ - Dimming down to 0.1% - 120V only
- TruPhase™, 0-10, DALI-2, DMX, Lutron or Casambi
- Flicker free to IEEE 1789-2015
- Prewired and integral to housing
- Universal 120-277v

Ordering Codes

PROJECT:

SPECIFIER:

DATE:

TYPE:

QUANTITY:

Ordering Code Example: CR3WW-RF-F-AU-C20-35-E2-P16-CP

FIXTURE	TRIM	MOUNTING	SOURCE / WATTS	CCT	DRIVER / CONTROL	TRIM FINISH	ACCESSORIES
<p>CR3WW-RF</p> <p>Core 3" Round Fixed Wall Wash</p>	<p>Z Flangeless Trim</p> <p>F Flanged Trim</p>	<p>ASPM * ●● Airtight Shallow Panel IC-Rated</p> <p>ASP * ●● Airtight Shallow Plaster IC-Rated</p> <p>ASU * ●● Airtight Shallow Universal IC-Rated</p> <p>●● Supports CA Title 24 Compliance</p>	<p>Citizen</p> <p>C14 ●● 14W 950Lm 90+CRI, 60+R9</p> <p>C20 20W 600Lm 90+CRI, 60+R9</p> <p>Tunable</p> <p>T9 90+CRI, 60+R9 Tunable White</p> <p>T15 90+CRI, 60+R9 Tunable White</p> <p>RGBW 90+CRI, 60+R9</p> <p>Ambient Dim™</p> <p>A14 ●● 15W 578Lm 95+CRI, 90+R9</p> <p>●● Supports CA Title 24 Compliance</p> <p>~See Photometrics chart for latest performance data</p>	<p>24 2400K</p> <p>27 2700K</p> <p>30 3000K</p> <p>35 3500K</p> <p>40 4000K</p> <p>Tunable</p> <p>TW1840 1800-4000K Tunable White w/ E1, E2, E3, E4</p> <p>TW2765 2700-6500K Tunable White w/ E1, E2, E3, E4</p> <p>RG1280 1200-8000K RGBW Dynamic Color Changing *Requires E2 or E4</p> <p>Ambient Dim™</p> <p>2722 2700-2200K * A14 Only</p> <p>3019 3000-1900K</p> <p>3022 3000-2200K * A14 Only</p>	<p>C1 0-10 1.0%, UNV (120-277V) linear</p> <p>C2 ELV/Triac 1.0%, (120V) linear</p> <p>E1 0-10 0.1%, UNV (120-277V) log</p> <p>E2 DALI-2 0.1%, UNV (120-277V) log</p> <p>E3 0-10 0.1%, UNV (120-277V) linear</p> <p>E4^ DMX 0.1%, UNV (120-277V) Universal DMX Driver/Controller RGBW-DMX ^ INCLUDES DMX/RDM COMPATIBLE DRIVER WITH BUILT-IN DECODER - CONTROLLER BY OTHERS</p> <p>TR2 TruPhase™ 0.1%, (120-120V) log Up to 20W Forward and Reverse compatible Phase Dimming Static White & Ambient Dim only</p>	<p>W White Paint</p> <p>B Black Paint</p> <p>D Wood*</p> <p>PXX Specialty Paint Color*</p> <p>P01-P15</p> <p>C Custom/RAL Color**</p> <p>* Wood "D" selection to be used with Z trim and PM mounting - Refer to Wood Trim Guide</p> <p>** Refer to Finish Guide</p> <p></p> <p></p>	<p>EM Emergency Pack Contact factory for options. Remote required.</p> <p>CP Chicago Plenum Controls</p> <p>ATH Lutron Athena Wireless Node Must be used with E2 driver</p> <p>CA Casambi Wireless BLE to be paired with driver</p>

Ceiling Cutouts and Dimensions

Round Flangeless Housing / **Panel Mount (Z/ASPM)**
CR3WW-RF-Z-ASPM-

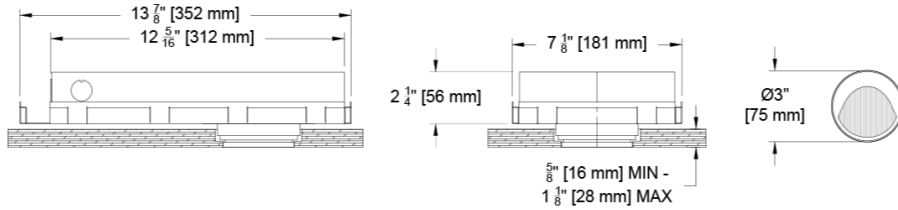
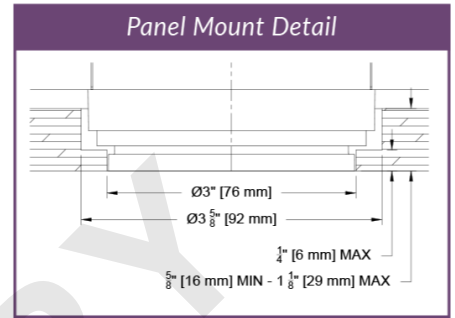

Round Flangeless Housing / **Plaster Mount (Z/ASP)**
CR3WW-RF-Z-ASP-

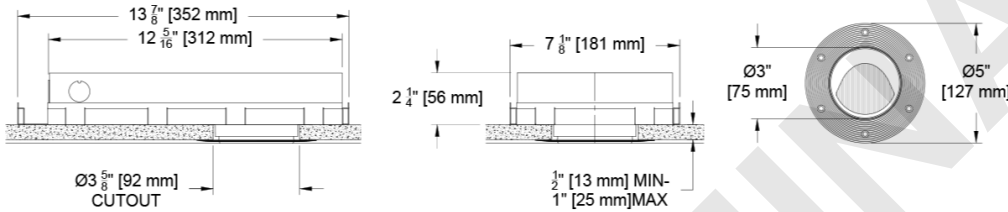
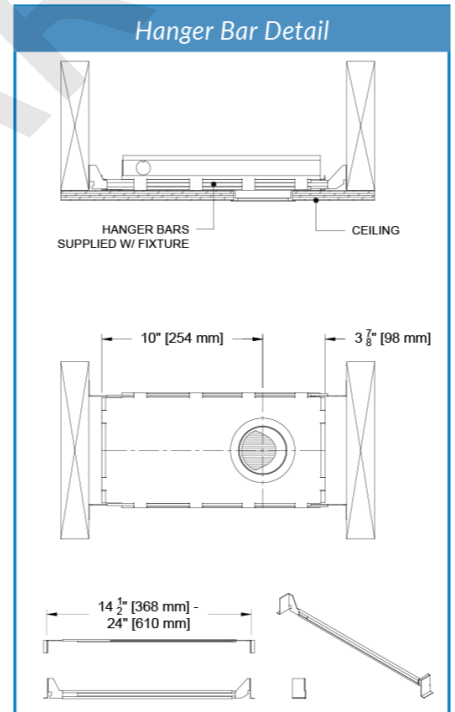

Round Flanged Housing / **Universal Mount (F/ASU)**
CR3WW-RF-F-ASU-

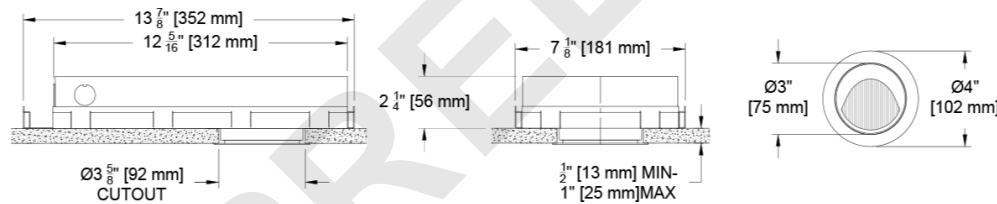

Photometric Table All data is based from goniometer measurements of production representative product. All lumen values can vary +/- 10% from LED manufacturer rated flux range. Measurements at 3000 CCT.

Round Wall Wash (CR4WW-RF)			
Source	System watts (W)	Delivered Lumens (lm)	Lumens/ Watt
Citizen C14	14	833	60
Citizen C20	20	1056	53
Citizen C28*	31	1616	53
Ambient Dim A14	14	578	40

CCT Multiplier	
CCT	Citizen
2700	0.95
3000	1.00
3500	1.02
4000	1.03

All data based on 3000k. See Multipliers for other CCT. Ambient Dim based on 3000k at full output. *C28 requires active cooling and cannot be used with IC housing or Chicago Plenum

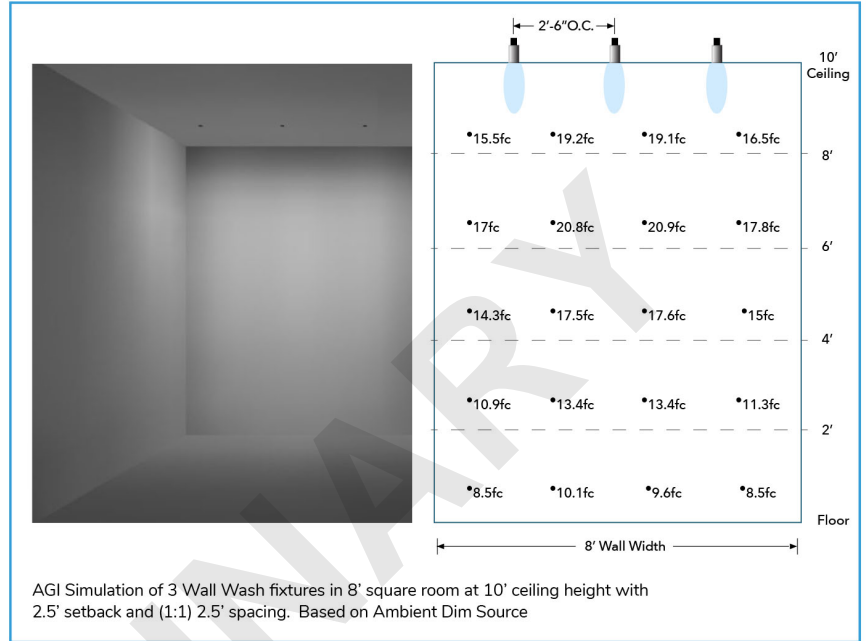

PRELIMINARY

Color Data

All data is based from goniometer measurements of production representative product. All values can vary +/- 10% from LED manufacturer rated data range.

Citizen CoB - C6, C8, C10, C14, & C20

- <3 MacAdam Ellipse (<3 SDCM)

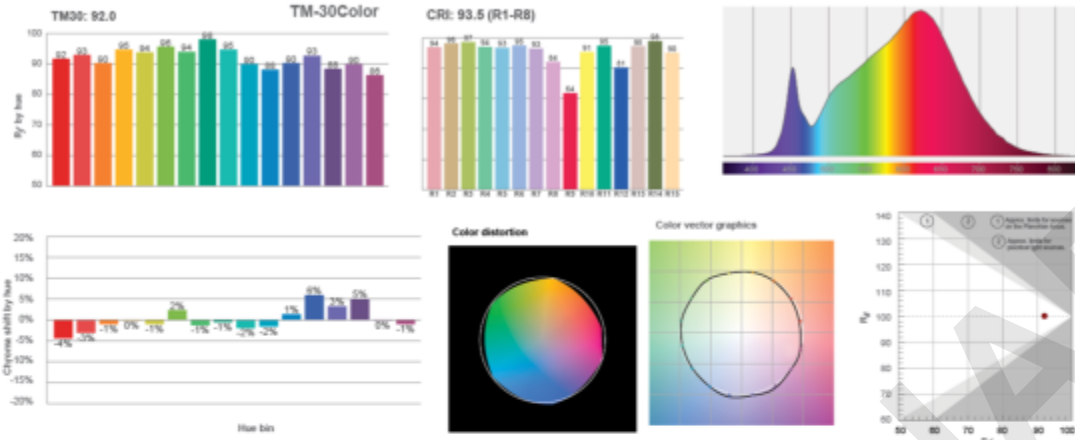

AmbientDim™ A14

- <3 MacAdam Ellipse (<3 SDCM)

